

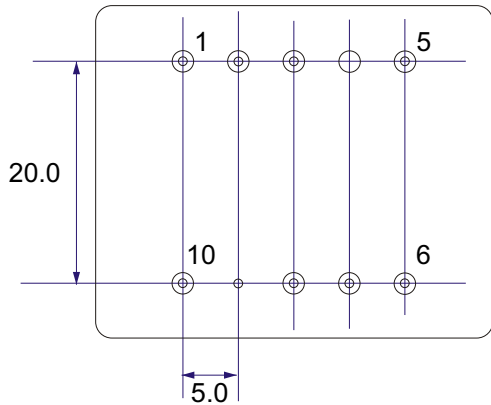

YY WW = date code

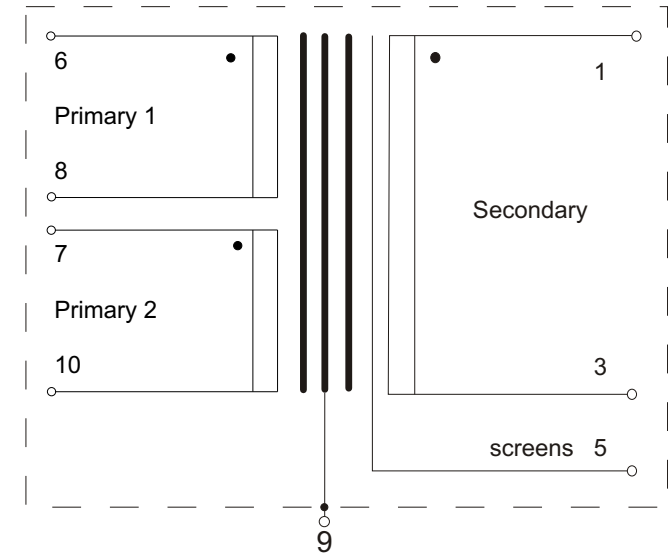
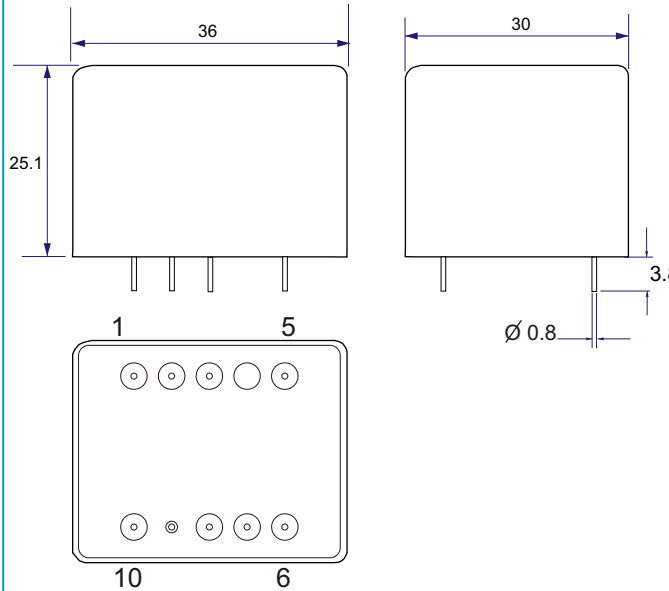
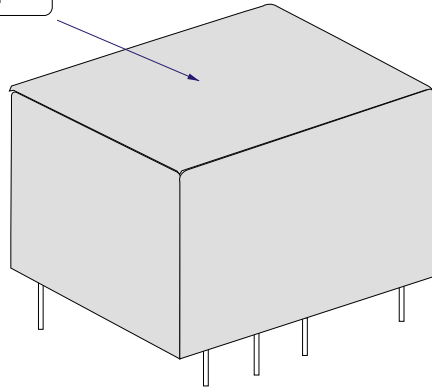

Pin view (underneath)

Mass = 0.11kg
Pin diameter = 0.80mm
Tolerance on can dimensions: +/- 0.5mm

Specification:

Turns ratio: 1+1 to 5
Impedance ratio: 150 to 10k

DC resistance (+/-15%)
Primary: 23.8 (wired in parallel)
Secondary: 300
Open circuit input impedance (): 3.74k @ 1kHz
Voltage gain @ 1kHz, 0dBu: 14.57 dBu (typ.)
Maximum input @ 20Hz for <1% THD: +4dBu

Leakage inductance @ 1kHz: 34mH (typ.) (6+10 S/C)

Capacitance @ 10kHz, 0.1V):
Cp-s: 17pF (typ.) with screen earthed
Cp-scr: 345pF (typ.)
Cs-scr: 445pF (typ.)

Hi-pot, primary to secondary: 500VDC
windings to can: 500VDC

Applications:

Medium impedance IC amplifiers
Input +4dBu max (20Hz) <1%THD
Galvanic isolation (500VDC)

Fitted with multiple electrostatic screens
Low distortion Mu-metal core
Mu-metal screening can reduce electrical noise by up to 30dB

Operating temperature range: 0 to +70°C
Storage temperature range: -25°C to +120°C

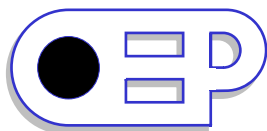

Unit 5, Oxonian Park, Langford Locks,
Kidlington, Oxfordshire. OX5 1FP
Tel: (01865) 855085 Fax: (01865) 855075
Website: www.carnhill.co.uk



Scale: nts.



DESCRIPTION

Specification for J30A11C
page 1 of 3

All dimensions in mm unless stated otherwise

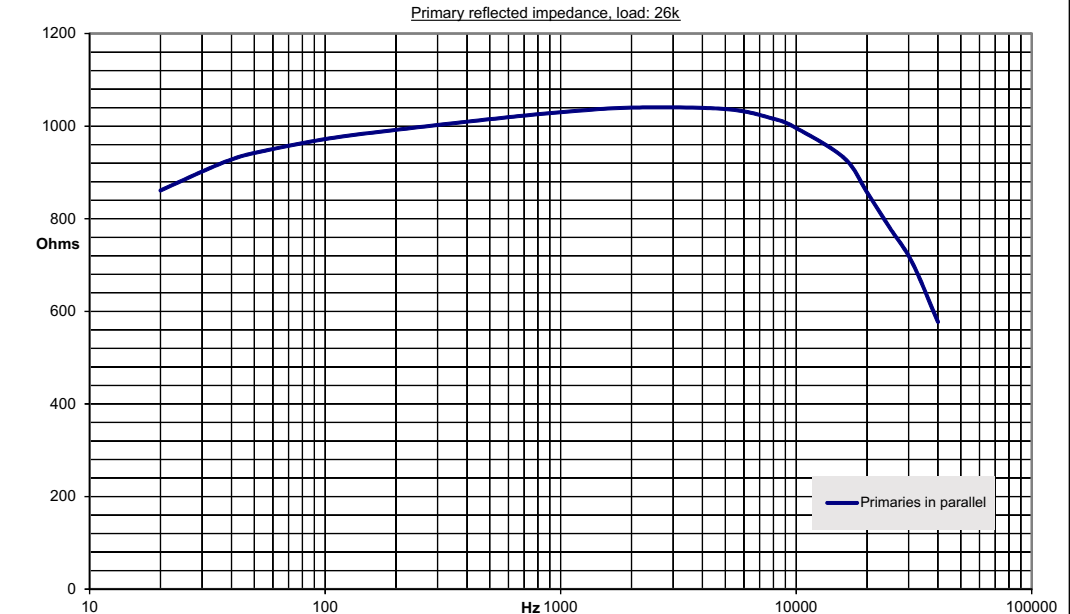
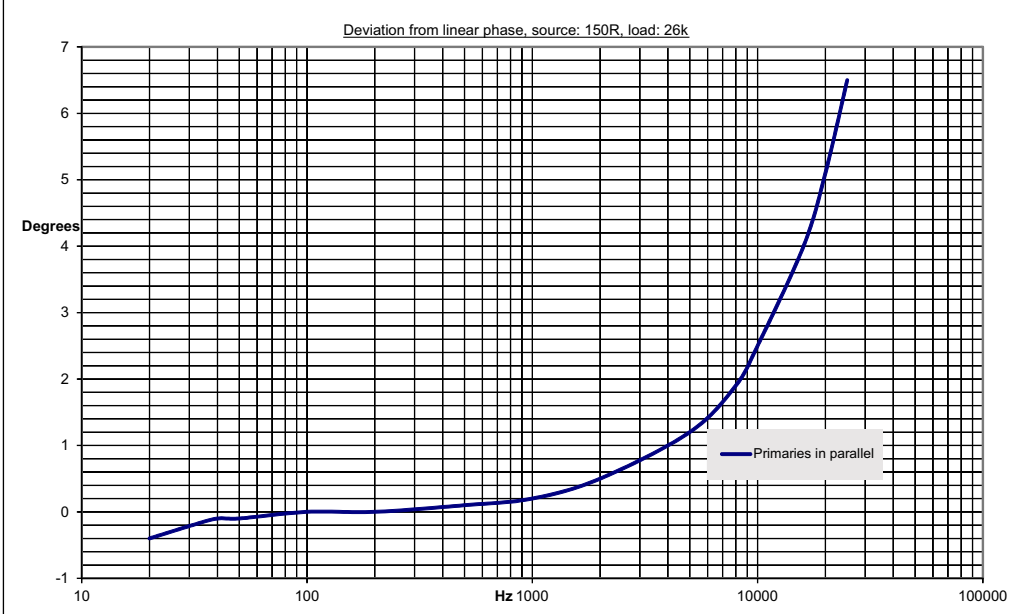
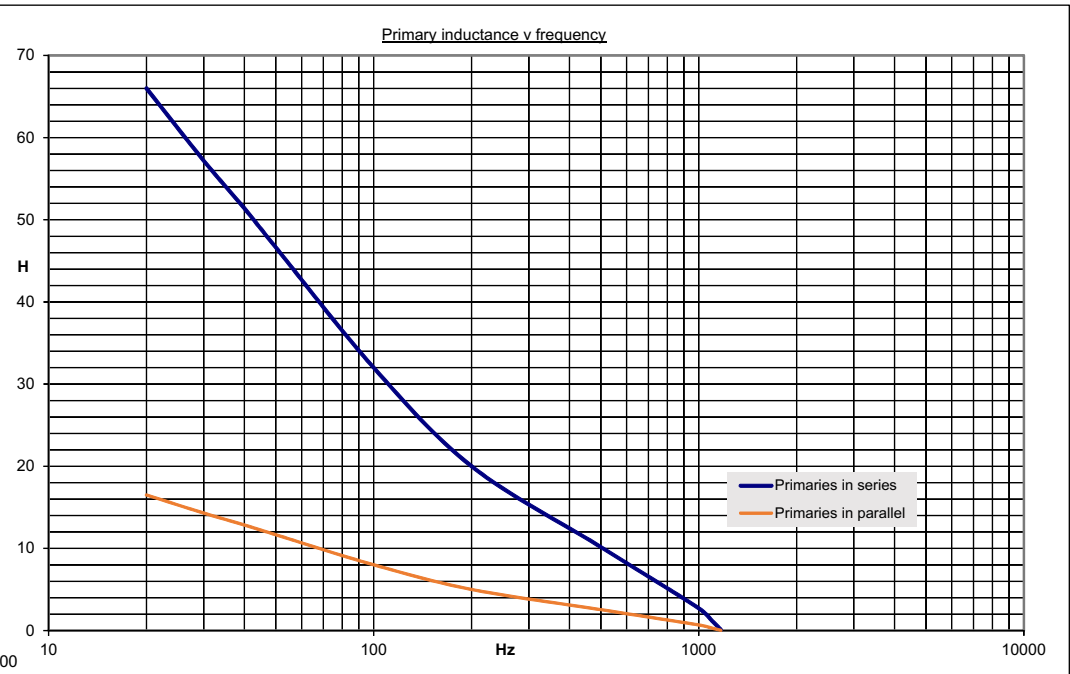
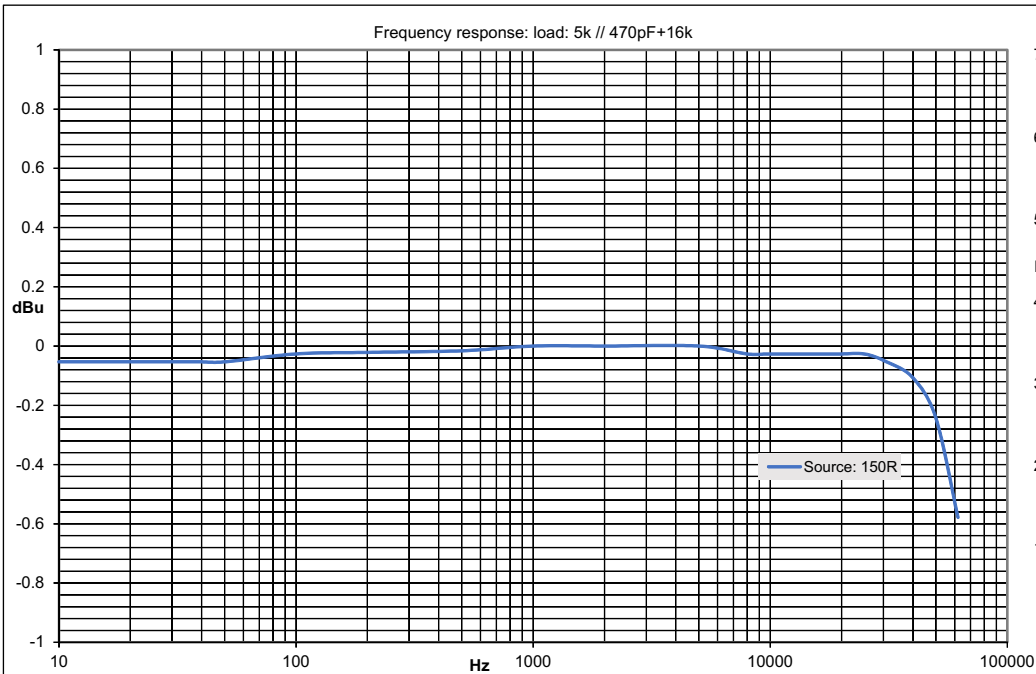
ISSUE	DATE	DRAWN	CHECKED	DRAWING NUMBER
1	03/12/12	CS		J30A11C
2	11/09/15	CS		
3	29/07/16	CS		
4	17/01/24	CS		

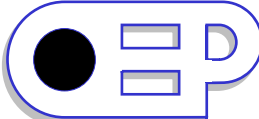

 <p>Unit 5, Oxonian Park, Langford Locks, Kidlington, Oxfordshire. OX5 1FP Tel: (01865) 855085 Fax: (01865) 855075 Website: www.carnhill.co.uk</p>	 Scale: nts.	DESCRIPTION				ISSUE 1 2 3 4	DATE 03/12/12 11/09/15 29/07/16 17/01/24	DRAWN CS CS CS CS	CHECKED	DRAWING NUMBER J30A11C
		Specification for J30A11C								
		page 2 of 3								
		All dimensions in mm unless stated otherwise								

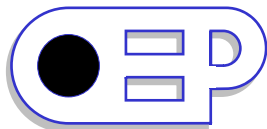
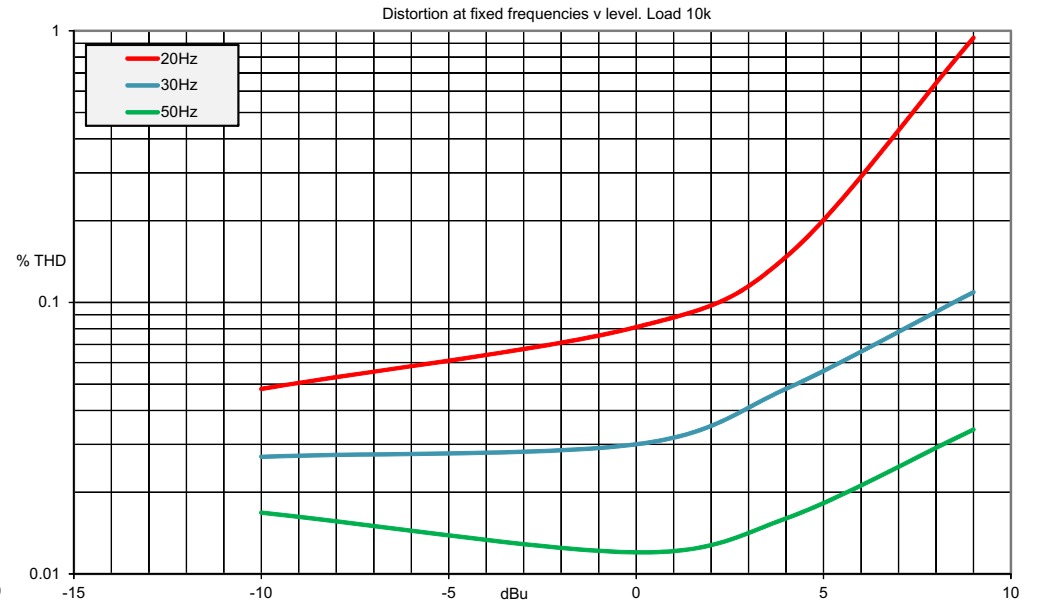
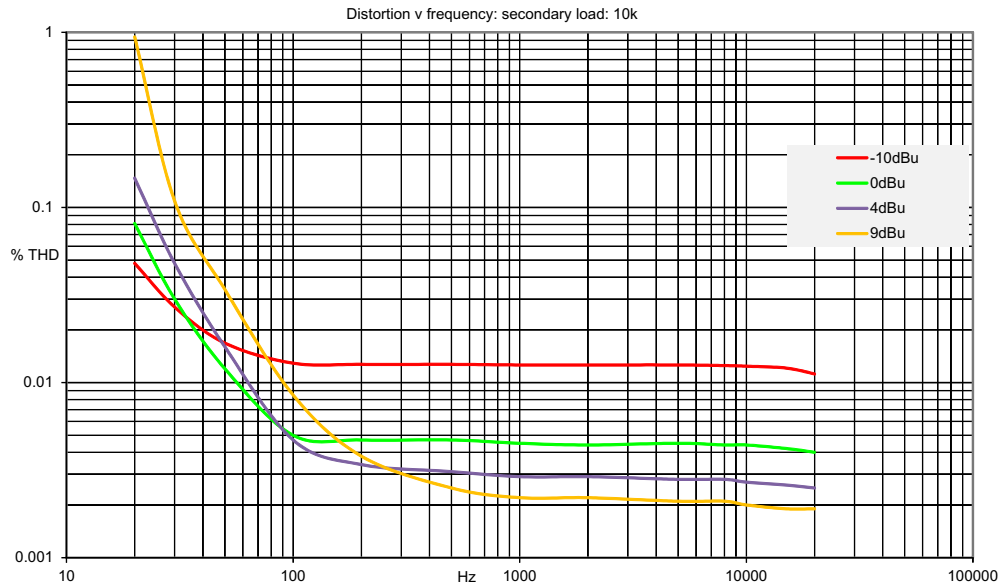

Unit 5, Oxonian Park, Langford Locks,
Kidlington, Oxfordshire. OX5 1FP
Tel: (01865) 855085 Fax: (01865) 855075
Website: www.carnhill.co.uk



Scale: nts.

DESCRIPTION

Specification for J30A11C
page 3 of 3

All dimensions in mm unless stated otherwise

ISSUE	DATE	DRAWN	CHECKED	DRAWING NUMBER
1	03/12/12	CS		J30A11C
2	11/09/15	CS		
3	29/07/16	CS		
4	17/01/24	CS		