

**J30A19C**  
 PRIMARY: 200  
 SECONDARY: 10k  
 Made in England

YY WW = date code

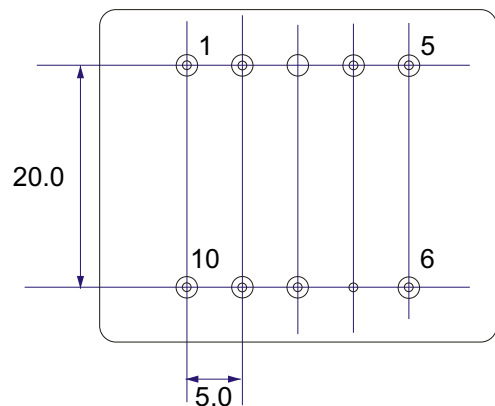
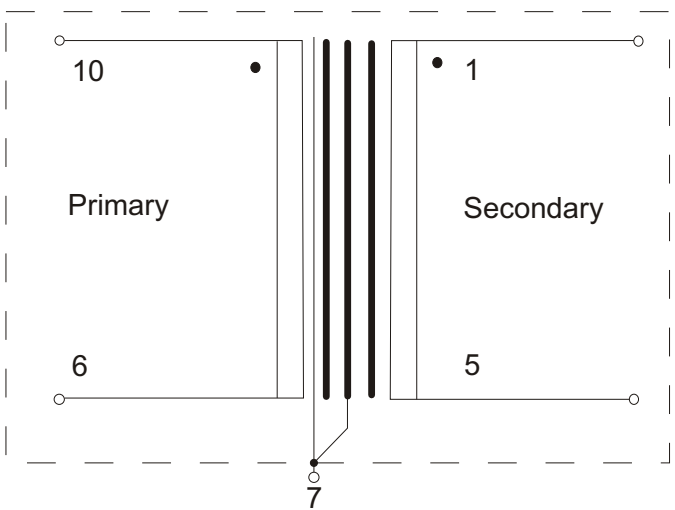
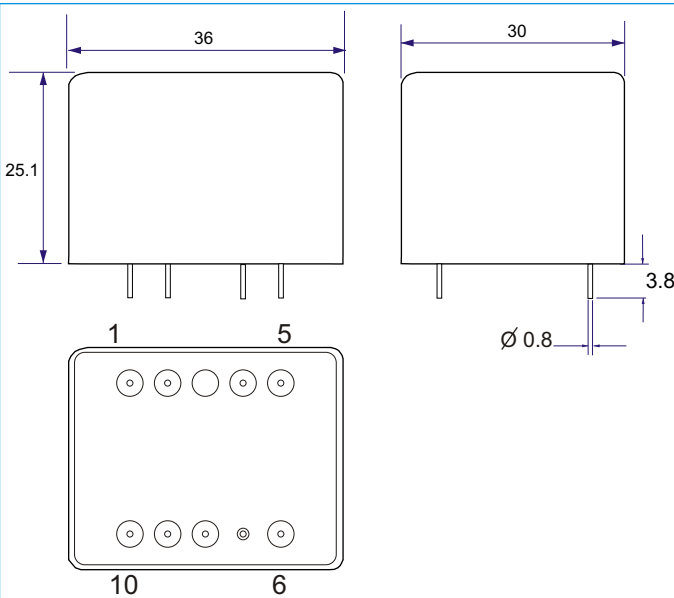
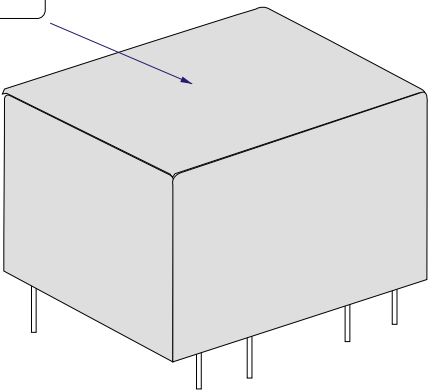

Pin view (underneath)

Mass = 0.11kg  
 Pin diameter = 0.80mm  
 Tolerance on can dimensions: +/- 0.5mm

Specification:

Turns ratio: 1 to 7  
 Impedance ratio: 200 to 10k

DC resistance ( +/-15%)  
 Primary: 26.7  
 Secondary: 1540  
 Open circuit input impedance @ 50mV ( ): 3.74k @ 20Hz  
 Voltage gain @ 1kHz, 0dBu: 14.57 dBu (typ.)

Leakage inductance @ 1kHz, 50mV: 34mH (typ.) (6+10 S/C)

Capacitance @ 10kHz, 0.1V):  
 Cp-s: 17pF (typ.) with screen earthed  
 Cp-scr: 345pF (typ.)  
 Cs-scr: 445pF (typ.)

Hi-pot, primary to secondary: 500VDC  
 windings to can: 500VDC

Applications:

High impedance amplifiers  
 Input signal 9dBu max (20Hz) <1%THD  
 Galvanic isolation (500VDC)

Fitted with multiple electrostatic screens  
 Low distortion Mu-metal core  
 Mu-metal screening can reduce electrical noise by up to 30dB

Operating temperature range: 0 to +70°C  
 Storage temperature range: -25°C to +120°C

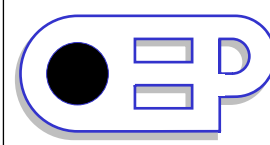

Unit 5, Oxonian Park, Langford Locks,  
 Kidlington, Oxfordshire. OX5 1FP  
 Tel: (01865) 855085 Fax: (01865) 855075  
 Website: [www.carnhill.co.uk](http://www.carnhill.co.uk)



Scale: nts.

**DESCRIPTION**

Specification for J30A19C  
 page 1 of 3

All dimensions in mm unless stated otherwise

ISSUE	DATE	DRAWN	CHECKED	DRAWING NUMBER
1	27/11/23	CS		<b>J30A19C</b>

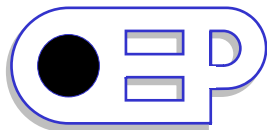
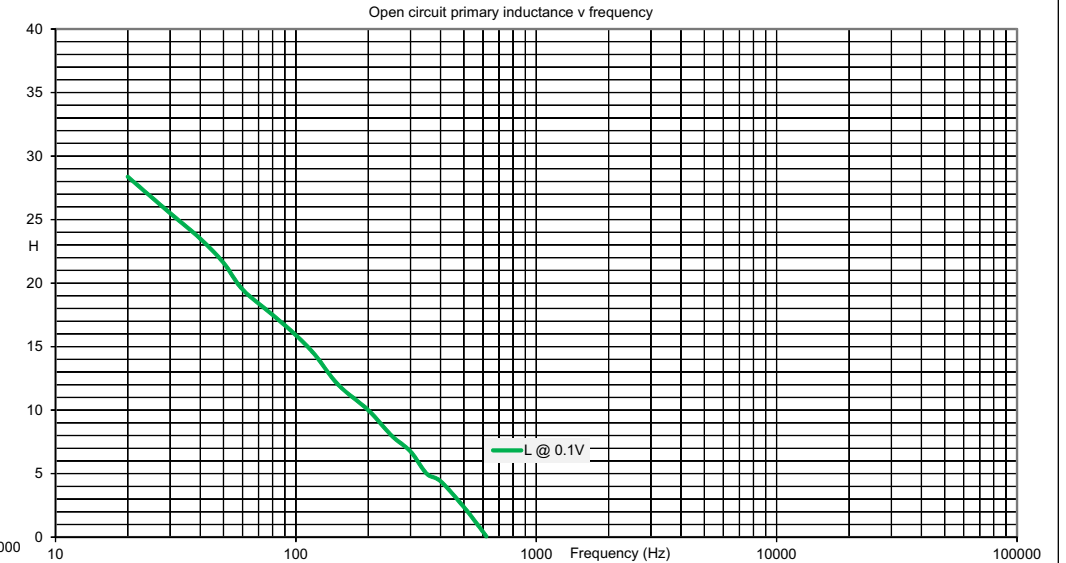
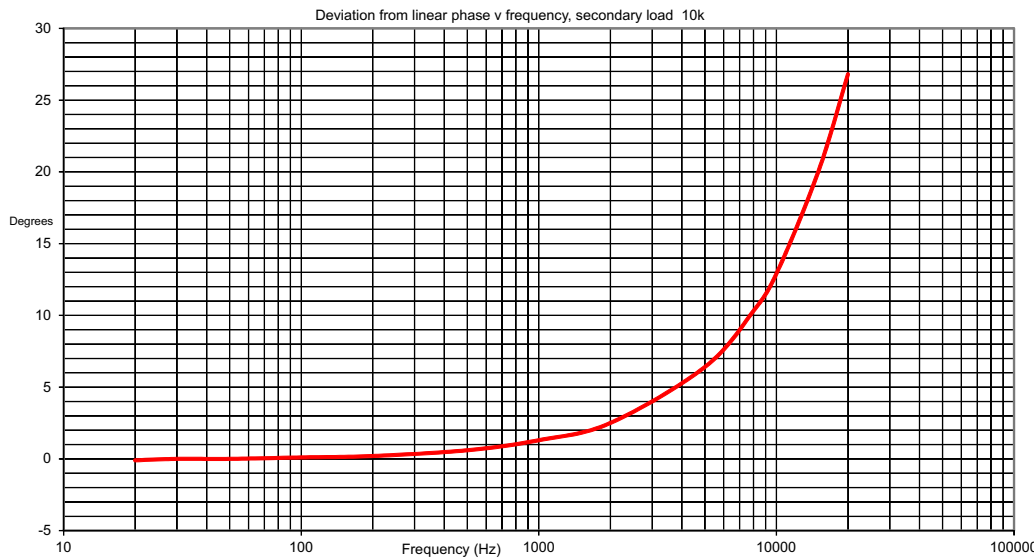
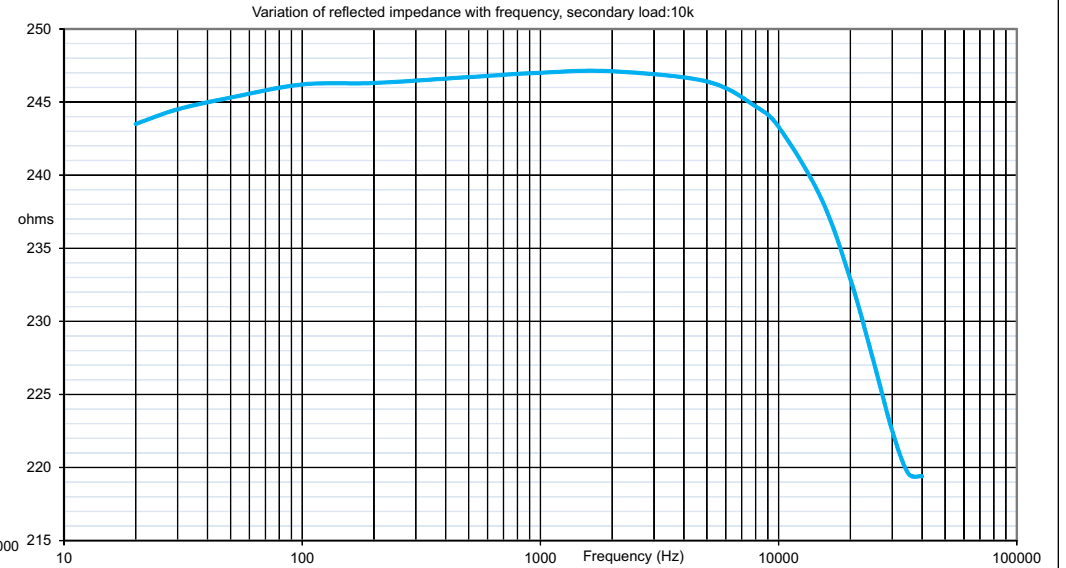
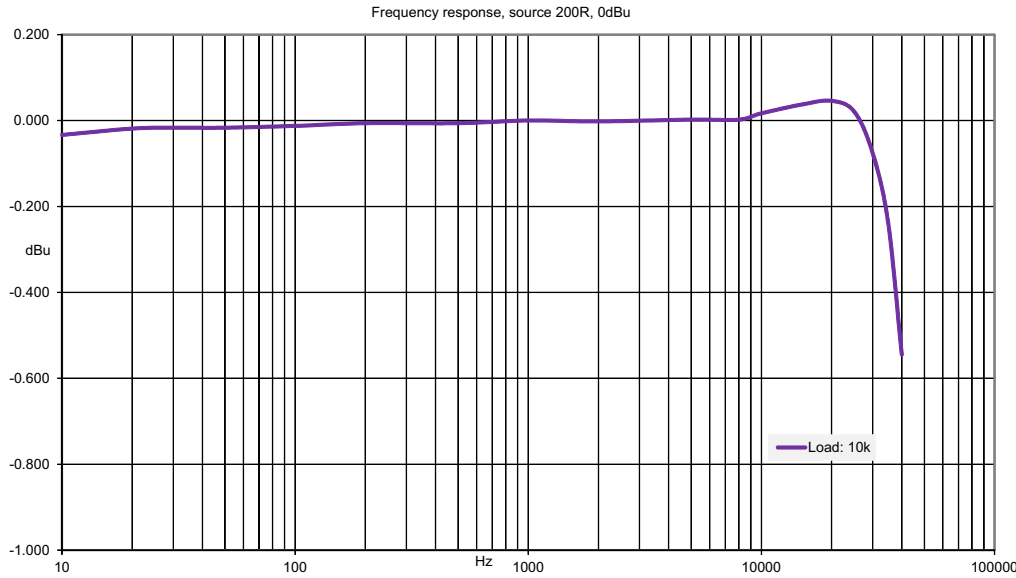

Unit 5, Oxonian Park, Langford Locks,  
Kidlington, Oxfordshire. OX5 1FP  
Tel: (01865) 855085 Fax: (01865) 855075  
Website: [www.carnhill.co.uk](http://www.carnhill.co.uk)



Scale: nts.

DESCRIPTION

Specification for J30A19C  
page 2 of 3

All dimensions in mm unless stated otherwise

ISSUE	DATE	DRAWN	CHECKED	DRAWING NUMBER
1	27/11/23	CS		<b>J30A19C</b>

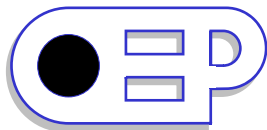
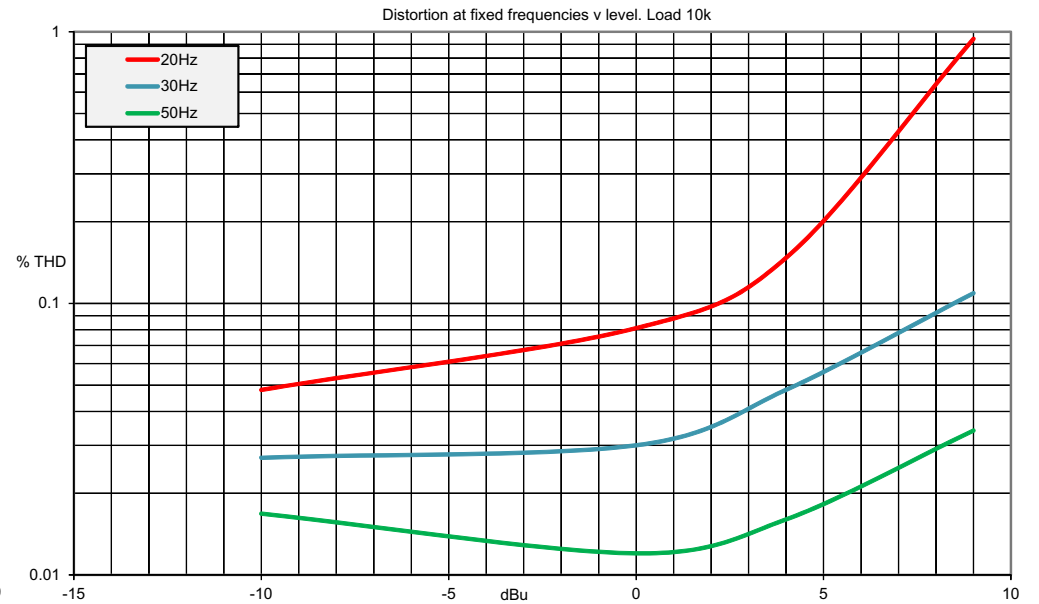
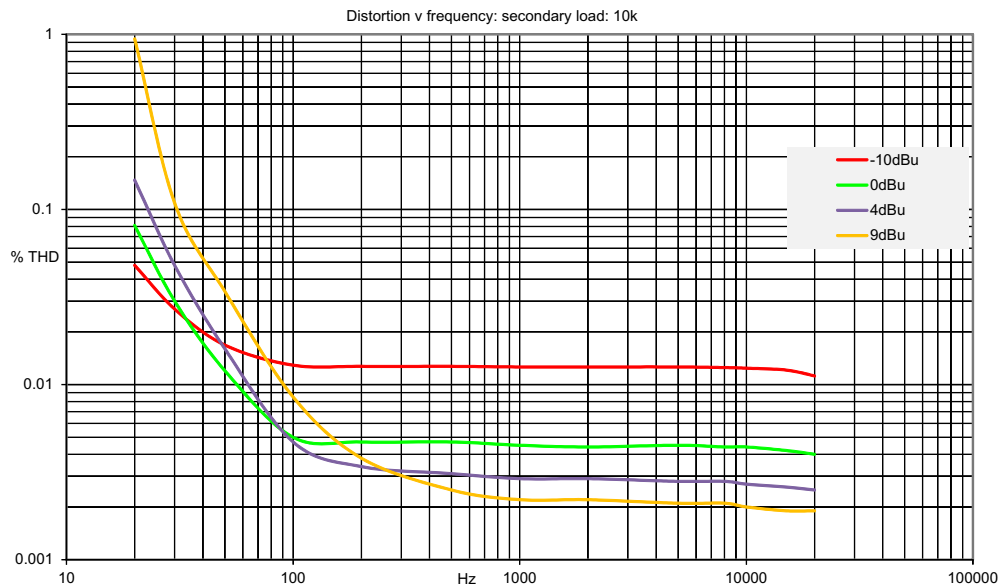

Unit 5, Oxonian Park, Langford Locks,  
Kidlington, Oxfordshire. OX5 1FP  
Tel: (01865) 855085 Fax: (01865) 855075  
Website: [www.carnhill.co.uk](http://www.carnhill.co.uk)



Scale: nts.

DESCRIPTION

Specification for J30A19C  
page 3 of 3

All dimensions in mm unless stated otherwise

ISSUE	DATE	DRAWN	CHECKED	DRAWING NUMBER
1	27/11/23	CS		<b>J30A19C</b>